

07.11.2020

Modelname / Model name / Nom du modèle / Modellnamn / Nome modello / Název modelu / Modelnaam / Ime modela / Numéro Modelo / Modell neve / Название модели / Názov modelu / Ime modela / Denumire model / Наименование на модела / Nazwa modelu

-DENVER-

Туре / Tipo / Тіpus / Тур / Тип / Тіp

61

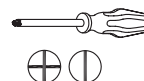
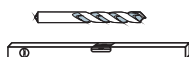
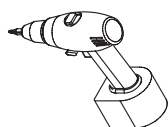
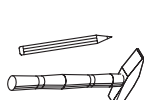
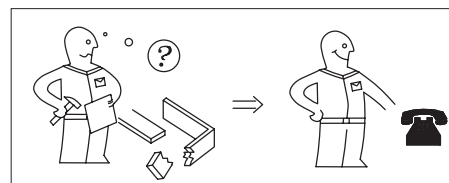
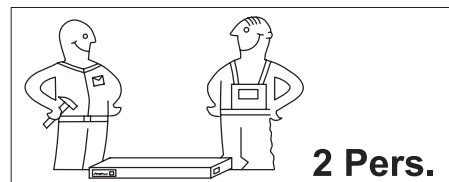
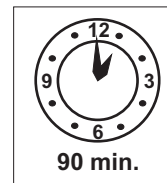
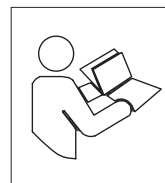
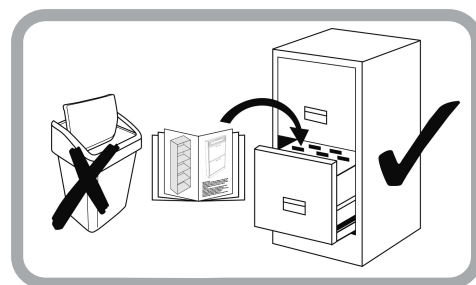
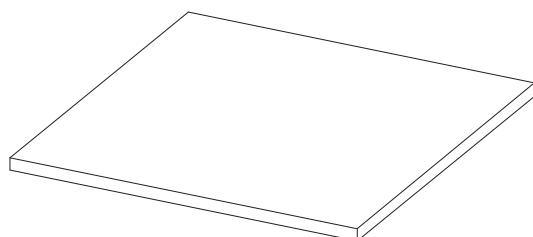

07.11.2020

Modelname / Model name / Nom du modèle / Modellnamn / Nome modello / Název modelu / Modelnaam / Ime modela / Número Modelo / Modell neve / Название модели / Názov modelu / Ime modela / Denumire model / Наименование на модела / Nazwa modelu

Type / Tipo / Típus / Тип / Тип / Tip

61

-DENVER-

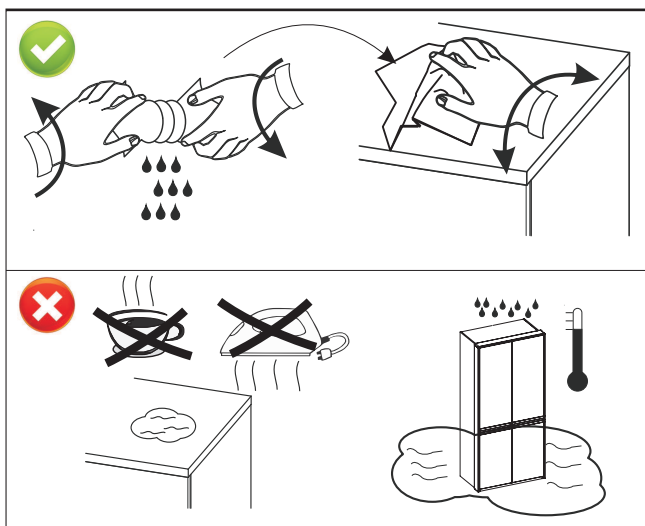
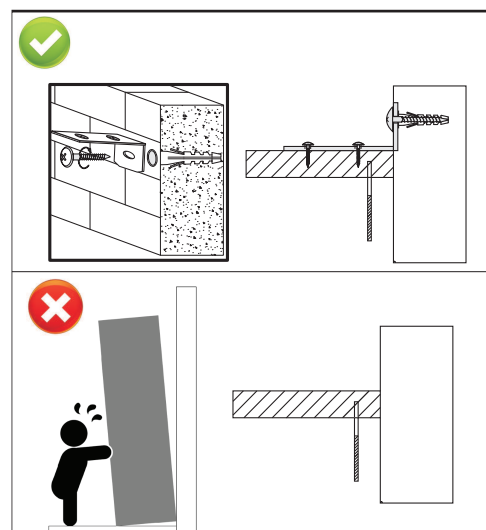
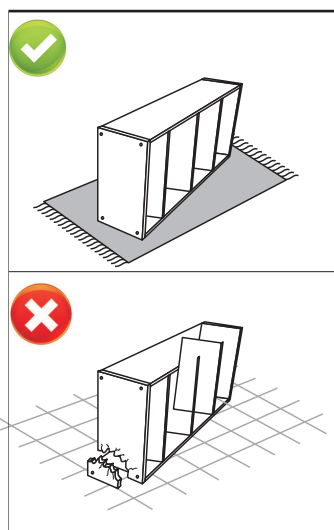
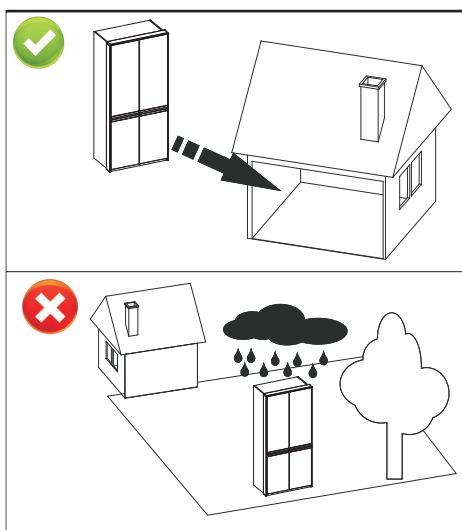
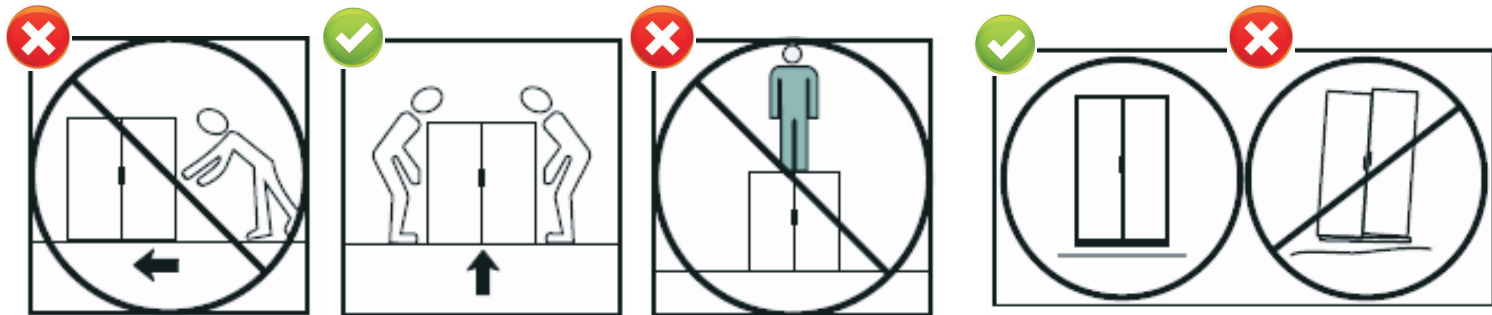

Tel: +48 601 247 625
 Tel: +48 601 677 210
 handel1@wmkm.eu
 www.wmkm.pl

07.11.2020

Modelname / Model name / Nom du modèle / Modellnamn / Nome modello / Název modelu / Modelnaam /
Ime modela / Numéro Modelo / Modell neve / Название модели / Názov modelu / Ime modela /
Denumire model / Наименование на модела / Nazwa modelu

Type / Tipo / Típus / Тип / Тип / Tip

-DENVER -

61

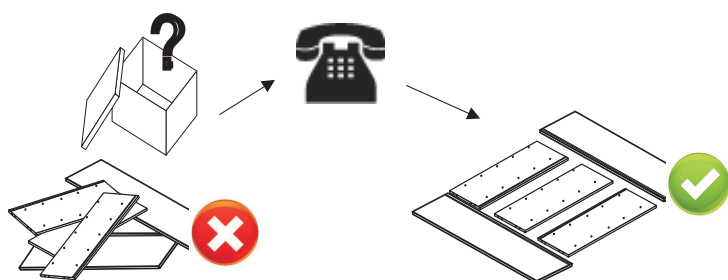
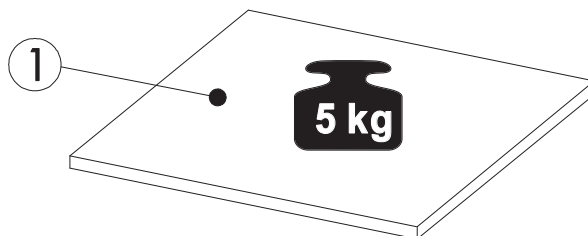
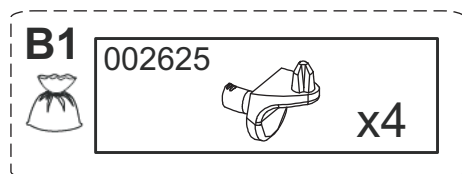

D

GBDear Customer. We would like to congratulate you buying a new furniture. Because we emphasize our customer satisfaction, please check very carefully the bag with fittings before you start assembling. If some parts are missing or are broken please mark it with sign on assembly instruction and send it to us.

Szanowny Kliencie. Gratulujemy zakupu nowego mebla. Ponieważ kładziemy duży nacisk na zadowolenie naszego Klienta, prosimy dokładnie sprawdzić torbę z okuciami zanim zaczniecie montować. Gdyby brakowało jakiejś części lub byłaby uszkodzona proszę to oznaczyć krzyżykiem na instrukcji montażowej i przesłać instrukcję.

